

 Cathedy GmbH		REVISION	A
		DATE	2023.09.20
PART NUMBER	A100-PD100W	CUSTOMER NAME AND MODEL	

Content

1.	Scope	4
2.	Type-C Support and USB-PD Support (Type-CUSB-PD)	4
3.	Quote Criterion	4
4.	Electrical Characteristic	5
5.	Input Characteristics.....	5
	5.1. Rated Input Voltage	5
	5.2. Input Voltage Range	5
	5.3. Rated Frequency	5
	5.4. Empty loaded wasting.....	5
	5.5. Frequency Range	6
	5.6. Steady AC Current.....	6
	5.7. Input Inrush Current	5
6.	Output Characteristics.....	6
	6.1. Rated Output Voltage.....	6
	6.2. Rated Power	6
	6.3. Output Ripple and Noise	7
	6.4. Average Efficiency	7
	6.5. Protection	6
	6.5.1. Over Current Protection	7
	6.5.2. Short Circuit Protection	7
	6.5.3. Over voltage protection	7
7.	Reliability Items	8
	7.1. Electrostatic Discharge	8
	7.2. Hi-Pot Test	7
	7.3. Insulation Resistance	7
	7.4. Leakage Current	7
	7.5. Temperature Rise	7
8.	Environmental Requirement	7
	8.1. Operating Temperature	7
	8.2. Storage Temperature	8
	8.3. Operating Humidity	8
	8.4. Storage Humidity	9
9.	Mechanical Requirement	9
	9.1. Input plug type	9
	9.2. Drop Test	8
	9.3. Salty Fog Test for Metal Part	8
10.	Mechanical Characteristics	9
	10.1. Appearance	9

 Cathedy GmbH		REVISION	A
		DATE	2023.09.20
PART NUMBER	A100-PD100W	CUSTOMER NAME AND MODEL	

10.2. Case Resin Materials	9
10.3. Vibration test	10
11. Environmental Performances.....	8
11.1. Operating at the Lower temperature	8
11.2. Operating at the High Temperature	9
11.3. Storage at the Lower Temperature	9
11.4. Storage at the Higher Temperature	9
11.5. Storage at High Temperature and High Humidity	10
11.6. Storage at low Temperature and Low Humidity	11
12. Photograph of the Product.....	11

 Cathedy GmbH		REVISION	A
		DATE	2023.09.20
PART NUMBER	A100-PD100W	CUSTOMER NAME AND MODEL	

1. Scope

The specification shall be applied to the field of IT and AV equipment

2. Type-C Support and USB-PD Support (Type-CUSB-PD)

USB-C 3.0A,

PD2.0 100W,

PD3.0,

BC1.20CP

3. Quote Criterion

3.1 Safety:accord with

①IEC 62368-1:2014, IEC 62368-1:2018

②EN 62368-1:2014A11:2017, EK1 557-13, AfPS GS 2019:01 PAK;

③EN 62368-1:2014A11:2017, BS EN 62368-1:2014A11:2017, BS EN IEC 62368-1:2020;

④UL 62368-1,2nd Ed, 2014-12-01(Audioideo, information and communication technology equipment Part 1: Safety requirements) , CANCSA C22.2 No. 62368-1-14, 2nd Ed, Issued: 2014-12-01(Audioideo, information and communication technology equipment Part 1: Safety requirements), UL 62368-1, Ed. 3, CANCSA C22.2 No. 62368-1:19

⑤GB 4943.1-2022

⑥ASNZS62368-1-2018, ASNZS62368-1-2022

⑦JP 62368-1(2020), JP 62368-1(2023)

⑧KC62368-1

⑨EN IEC 62368-1:2020A11:2020

3.2 EMI STANDARD (EMI)

①EN 55032:2015A11:2020, EN IEC 61000-3-2:2019A1:2021, EN 61000-3-3:2013A1:2019, EN 55035:2017A11:2020, BS EN 55032:2015A11:2020, BS EN IEC 61000-3-2:2019A1:2021, BS EN 61000-3-3:2013A1:2019, BS EN 55035:2017A11:2020

②EN 55032:2015A11:2020, EN IEC 61000-3-2:2019, EN 61000-3-3:2013A1:2019, EN 55035:2017A11:2020

③GBT9254:2008, GB17625.1:2012, GBT9254:2021, GB17625.1:2022

④47 CFR FCC Part 15, Subpart B, ANSI C63.4-2014

⑤EN 55032, EN IEC 61000-3-2, EN 61000-3-3, EN 55035, BS EN 55032, BS EN IEC 61000-3-2, BS EN 61000-3-3 and BS EN 55035

⑥EN 55032,EN 55035, EN IEC 61000-3-2, EN 61000-3-3

⑦ASNZS CISPR 32:2015+A1:2020

 Cathedy GmbH		REVISION	A
		DATE	2023.09.20
PART NUMBER	A100-PD100W	CUSTOMER NAME AND MODEL	

⑧KN 32, KN 35, KS C 9832:2023, KS C9835:2019

⑨J55032(H29)

4. Electrical Characteristic

Test Circuit

If the test is to be made on a specified circuit, be sure to use the following circuit.

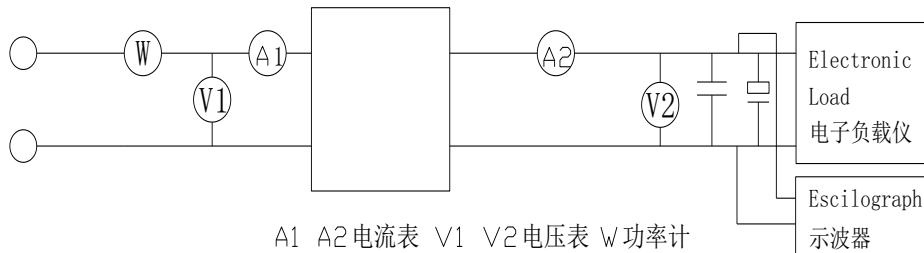

5. Input Characteristics

5.1. Rated Input Voltage

It is normal for 100Vac to 240Vac input AC voltage.

5.2. Input Voltage Range

The adapter shall operate from 90 to 264Vac and the range switching is unnecessary.

5.3. Rated Frequency

It is normal for 50Hz or 60Hz and single phase.

5.4. Empty loaded wasting

The Input power is 150mW(0.15W) or less in empty loaded. **(Output Voltage:5V)**

5.5. Frequency Range

The adapter shall operate with an input frequency from 47Hz to 63Hz.

5.6. Steady AC Current

Maximum steady state input current is 1.5A (Max) Measured at 100Vac input and maximum load.

5.7. Input Inrush Current

With cold starting, the Input Inrush current should less than 100A.

 Cathedy GmbH		REVISION	A
		DATE	2023.09.20
PART NUMBER	A100-PD100W	CUSTOMER NAME AND MODEL	

6. Output Characteristics

6.1. Rated Output Voltage Current

Model	6.1 Output Voltage	6.1 Min Load	6.1 Output Current	6.1 Load Regulation	6.1 Line Regulation	6.1 Output Voltage Range	6.2 Rated Power	6.3 RippleNoise (p-p)	6.4 average efficiency	6.5.1 Over Current Protection
A100-PD100W	5V	0A	3A	-5%~+8%	±1%	4.75V-5.40V	15W	200mV Max	81.84% Min	4.4A Max
	9V	0A	3A	±5%	±1%	8.55V-9.45V	27W	200mV Max	87.30% Min	4.4A Max
	12V	0A	3A	±5%	±1%	11.4V-12.6V	36W	200mV Max	88.30% Min	4.4A Max
	15V	0A	3A	±5%	±1%	14.25V-15.75V	45W	200mV Max	88.85% Min	4.4A Max
	20V	0A	5A	±5%	±1%	19.0V-21.0V	100W	400mV Max	89% Min	6.5A Max

6.2. Rated Power

This adapter is capable to support Rated Max Power continuously at all specified conditions. Note: the test shall be made under the following conditions, unless otherwise specified: Ambient Temperature 25°C, Relative Humidity 35~85%RH Air Pressure 86~106kPa

6.3. Output Ripple and Noise

6.3.1 AC Input 115V60Hz,230V50Hz. Output ripple voltage is less Measured methods:Performed by 20MHz bandwidth in oscilloscope. Applied 0.1uF ceramic capacitor and 10uF electrolytic capacitor across output connector terminals Measured at the end of DC cable.(AC115V60Hz,230V50Hz. 0.1uF 10uF , 20MHz)

6.3.2 Turn on delay time:

3Second Max.at 115Vac input and output Max.load.

6.3.3 Rise time:

40 mS Max.at 115Vac input and output Max load.

6.3.4 Hold up time:

5 mS Min.at 115Vac input and output Max.Load.

6.4. Average Efficiency

Measured at 115Vac and 230Vac input voltage, maximum load .DOE or ERP (level VI), All data was measurement at pcb end.

 Cathedy GmbH		REVISION	A
		DATE	2023.09.20
PART NUMBER	A100-PD100W	CUSTOMER NAME AND MODEL	

6.5. Protection

6.5.1. Over Current Protection

Output over current protection current is limited and less than the maximum value

6.5.2. Short Circuit Protection

When the output is shorted, the input power is reduced and will not damage, there will be (burp state). When the fault condition is removed, the product will be automatically returned to normal

6.5.3. Over voltage protection

The power supply will auto recovered when faults remove 120%~150%.

7. Reliability Items

7.1. Electrostatic Discharge

At 150pF: 330Ω, for each point, 10 shots of direct discharge or air discharge. (1 MΩSHOT), have no malfunction. Direct discharge: ±4kV, Air discharge: ±8kV

7.2. Hi-Pot Test

After AC 3000V1min between input plug-DC plug. cutoff current 5mA, the adapter have no failures like damages, arch, insulation damage etc. (at 25° C)

7.3. Insulation Resistance

At 25° C after DC 500V 1min between input plug- DC plug, insulation resistance 7MΩmin)

7.4. Leakage Current

0.25mA maximum, at nominal AC input voltage and frequency

7.5. Temperature Rise

At 25°C with the rated input 100-240Vac charged to the primary a rated load on the secondary ,every parts of the case surface rise 77°C or less,

8. Environmental Requirement

8.1. Operating Temperature

-10°C TO 40°C Full load, Normal operation.,.

8.2. Storage Temperature

-25°C TO +70°C With package

8.3. Operating Humidity

5%(0°C)~90%(40°C),RH,72Hrs,Full load, Normal operating.

 Cathedy GmbH		REVISION	A
		DATE	2023.09.20
PART NUMBER	A100-PD100W	CUSTOMER NAME AND MODEL	

8.4. Storage Humidity

5% ~ 95% RH. Non-condensing

9. Mechanical Requirement

9.1. Input plug type

IEC-320-C6

9.2. Drop Test

From 100cm height to the most likely to cause adverse results to the horizontal position of the surface drop test bed three times, the adapter in addition to surface scratches, it should be no dysfunction can cause the adapter and other potentially the harm. (Horizontal surface of the test rig shall be composed of at least 13mm thick hardwood installed in two layers of plywood, each layer of plywood thickness 19-20mm, and then placed on a cement base or equivalent on the ground inelastic)

9.3. Salty Fog Test for Metal Part

Experiment condition, Salty water thickness: 5%, Equipment Temperature: 35 ~ 40 °C ,put the adapter(unpacking)in the test equipment for 24h, after 24h recovery at 25°C checking the appearance, the metal parts have no erode and rust.

10. Mechanical Characteristics

10.1. Appearance

Visual inspection the case have no visual abnormality, no obvious nick, burr and other mechanical damage, outer metal have no rust. Use limit sample to check for any failures.

10.2. CaseResin Materials

Flame resistance applies to UL94-V1

10.3. Vibration test

The amplitude is 25.4mm, the frequency is 4.5Hz, the speed is 270 revolutions per 53 minutes, and the vibration frequency is 14200 times. When the vibration is half done, rotate the goods horizontally by 90 ° or 180 ° and continue to vibrate. After the test, there are no abnormalities

11. Environmental Performances

11.1. Operating at the Lower temperature

At -10±2°C, with the rated voltage 100-240Vac charged to the primary and unloaded and full load on the secondary, no abnormality in electric and mechanical characteristic, after 2 hours recovery at the room temperature.

 Cathedy GmbH		REVISION	A
		DATE	2023.09.20
PART NUMBER	A100-PD100W	CUSTOMER NAME AND MODEL	

11.2. Operating at the High Temperature

At $40\pm 2^{\circ}\text{C}$, with the rated voltage 100-240Vac charged to the primary and unloaded and full load on the secondary. No abnormality in electric and mechanical characteristic after 2 hours recovery at the room temperature.

11.3. Storage at the Lower Temperature

At $-25\pm 2^{\circ}\text{C}$, test of non-operated, No abnormality in electric and mechanical characteristic after 2 hours recovery at the room temperature.

11.4. Storage at the Higher Temperature

At $70\pm 2^{\circ}\text{C}$, test of non-operated, No abnormality in electric and mechanical characteristic after 2 hours recovery at the room temperature.

11.5. Storage at High Temperature and High Humidity

At $40\pm 2^{\circ}\text{C}$, 90~95%RH, test of operating 48 hours, no abnormality in electric and mechanical characteristic, after 4 hours recovery at the room temperature.

11.6. Storage at low Temperature and Low Humidity

At $-10^{\circ}\text{C} \pm 2^{\circ}\text{C}$, 10%~40%RH, test of operating 48 hours, no abnormality in electric and mechanical characteristic, after 4 hours recovery at the room temperature.

12. Photograph of the Product

12.1 Enclosure:

The power supply size: L 145.89 x W 59.19 x H 28.5mm; : L 145.89 x W 59.19 x H 28.5mm;

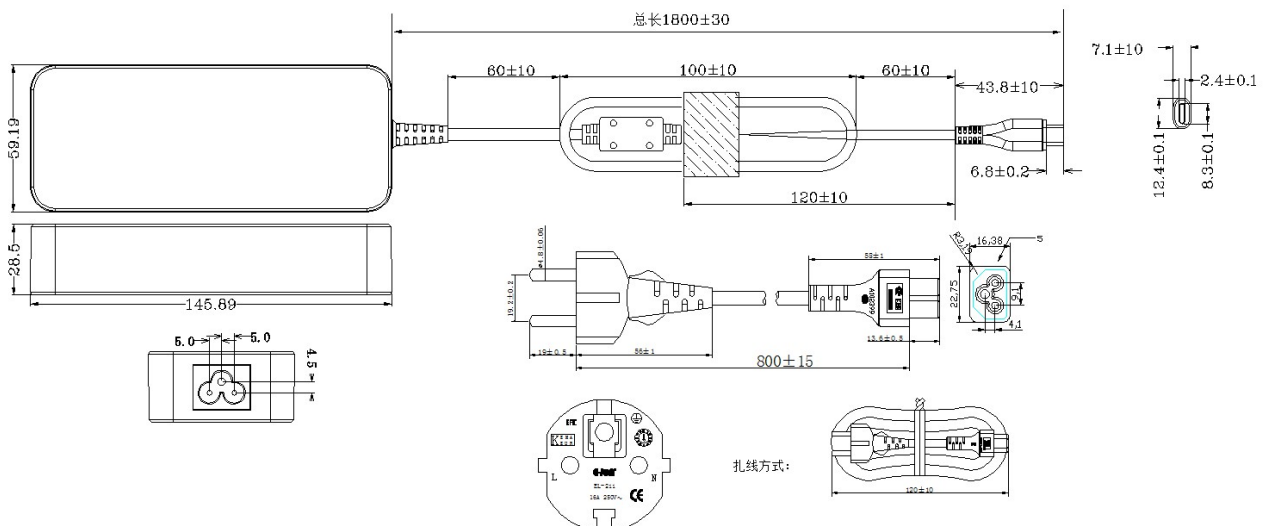

 Cathedy GmbH		REVISION	A
		DATE	2023.09.20
PART NUMBER	A100-PD100W	CUSTOMER NAME AND MODEL	



 Cathedy GmbH		REVISION	A
		DATE	2023.09.20
PART NUMBER	A100-PD100W	CUSTOMER NAME AND MODEL	

